

Total solder points: 109

Difficulty level:

beginner 1 2 3 4 5 advanced

HIGH-Q
velleman-kit 

AC Power slave

K8034

Features:

- This module will certainly come in handy if, when activating one device (or a light or a series of lights), you wish to activate a second device.
- Detects small resistive and inductive loads.
- Adjustable sensitivity.
- Protected against current variations in master load.
- Relay contacts with inductive kick protection.
- Power indication.

Specifications :

- Master + Slave:
 - AC Power : 115 or 240 VAC.
 - Max. Load : 2A (500w / 240VAC - 250W / 115VAC).
- Relay contact rating:
 - AC Power : 115 of 240 VAC.
 - Max. Load : 5A (1100w / 240VAC - 550W / 115VAC).
- Minimal detectable LOAD : 5W (Cos f = 1).
- Dimensions : 100 x 83 X 35 mm. (4" x 3.3" x 1.4")



1. Assembly (Skipping this can lead to troubles !)

Ok, so we have your attention. These hints will help you to make this project successful. Read them carefully.

1.1 Make sure you have the right tools:

- A good quality soldering iron (25-40W) with a small tip. 
- Wipe it often on a wet sponge or cloth, to keep it clean; then apply solder to the tip, to give it a wet look. This is called 'thinning' and will protect the tip, and enables you to make good connections.
When solder rolls off the tip, it needs cleaning.

- Thin rosin-core solder. Do not use any flux or grease.



- A diagonal cutter to trim excess wires. To avoid injury when cutting excess leads, hold the lead so they cannot fly towards the eyes.

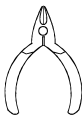

- Needle nose pliers, for bending leads, or to hold components in place.

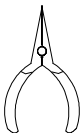

- Small blade and Phillips screwdrivers. A basic range is fine.



For some projects, a basic multi-meter is required, or might be handy

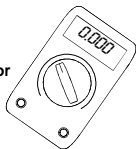

1.2 Assembly Hints :

- ⇒ Make sure the skill level matches your experience, to avoid disappointments.
- ⇒ Follow the instructions carefully. Read and understand the entire step before you perform each operation.
- ⇒ Perform the assembly in the correct order as stated in this manual
- ⇒ Position all parts on the PCB (Printed Circuit Board) as shown on the drawings.
- ⇒ Values on the circuit diagram are subject to changes.
- ⇒ Values in this assembly guide are correct*
- ⇒ Use the check-boxes to mark your progress.
- ⇒ Please read the included information on safety and customer service

* Typographical inaccuracies excluded. Always look for possible last minute manual updates, indicated as 'NOTE' on a separate leaflet.

1.3 Soldering Hints :

Mount the component against the PCB surface and carefully solder the leads

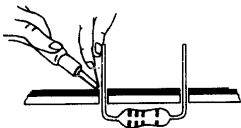

Make sure the solder joints are cone-shaped and shiny



Trim excess leads as close as possible to the solder joint

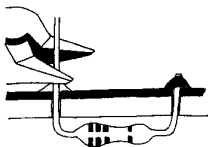

AXIAL COMPONENTS ARE TAPED IN THE CORRECT MOUNTING SEQUENCE !

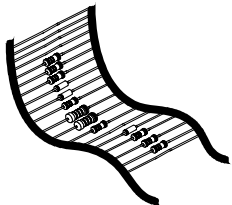

REMOVE THEM FROM THE TAPE ONE AT A TIME !

5%

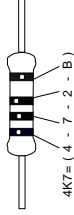

4K7 = (4 - 7 - 2 - B)

1%

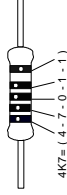

4K7 = (4 - 7 - 0 - 1 - 1)

COLOR= 2...5



	I	P	E	SF	S	DK	N	D	GB	F	NL
C O D E	CODICE COLORE DE CORES	CODIGO DE CORES	VÄRI KOODI	FÄRG SCHEMA	FARVE- KODE	FARGE- KODE	FARB KODE	COLOUR CODE	CODIFI- CATION DES COU- LEURS	KLEUR KODE	C O D E
0	Nero	Preto	Negro	Musta	Svart	Sort	Sort	Schwarz	Black	Noir	Zwart 0
1	Marrone	Castanho	Marrón	Ruskea	Brun	Brun	Brun	Braun	Brown	Brun	Bruin 1
2	Rosso	Encarnado Rojo		Punainen	Röd	Röd	Röd	Rot	Red	Rouge	Rood 2
3	Aranciato	Laranja	Naranja	Oranssi	Orange	Orange	Orange	Orange	Orange	Orange	Oranje 3
4	Giallo	Amarelo	Amarillo	Keltainen	Gul	Gul	Gul	Gelb	Yellow	Jaune	Geel 4
5	Verde	Verde	Verde	Vihreä	Grön	Grøn	Grønn	Grün	Green	Vert	Groen 5
6	Blu	Azul	Azul	Sininen	Blå	Blå	Blå	Blau	Blue	Bleu	Blauw 6
7	Viola	Violeta	Morado	Purppura	Lila	Violet	Violet	Violet	Purple	Violet	Paars 7
8	Grigio	Cinzeno	Gris	Harmaa	Grå	Grå	Grå	Grau	Grey	Gris	Grijs 8
9	Bianco	Branco	Bianco	Valkoinen	Vit	Hvidt	Hvidt	Weiss	White	Blanc	Wit 9
A	Argento	Prateado	Plata	Hopea	Silver	Sølv	Sølv	Silber	Silver	Argent	Zilver A
B	Oro	Dourado	Oro	Kulta	Guld	Guld	Guldi	Gold	Gold	Or	Goud B

1. Jumper wires

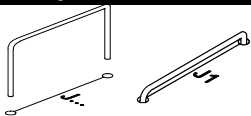

- J1
- J2
- J3

2. Resistors

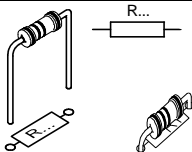

- R2: 100 (1-0-1-B-9)
- R3: 2K2 (2-2-2-B)
- R4: 1K (1-0-2-B)
- R5: 4K7 (4-7-2-B)
- R6: 4K7 (4-7-2-B)
- R7: 220K (2-2-4-B)
- R8: 4M7 (4-7-5-B)
- R9: 10K (1-0-3-B)
- R10: 470K (4-7-4-B-9)

3. Diodes

Watch the polarity !

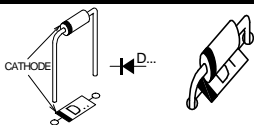

- D5 : 1N4007
- D6 : BAT85
- D7 : 1N4148

4. 1W Resistor

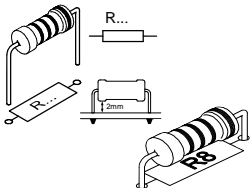

- R1: 220 (2-2-1-B)

5. IC socket, *Watch the position of the notch !*

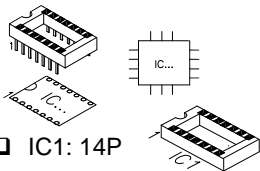

- IC1: 14P

6. Power diodes

Watch the polarity !

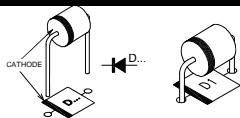

- D1 : 1N5404 or Eq.
- D2 : 1N5404 or Eq.
- D3 : 1N5404 or Eq.
- D4 : 1N5404 or Eq.

7. Zener diodes

Watch the polarity !

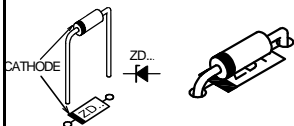

- ZD1: 8V2 / 1.3W
- ZD2: 8V2 / 1.3W
- ZD3: 8V2 / 1.3W

8. Capacitors

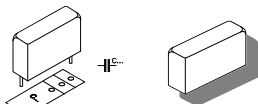

- C1 : 1 μ F/600V

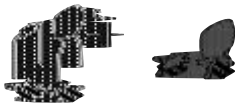

- C5 : 100nF (104 - μ 1)
- C6 : 100nF (104 - μ 1)
- C7 : 100nF (104 - μ 1)

9. Electrolytic Capacitors.

Watch the polarity !

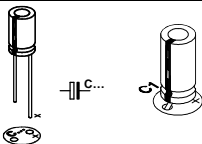

- C2: 220 μ F
- C3: 4 μ 7
- C4: 4 μ 7

10. LED's.

Watch the polarity !

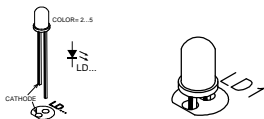

- LD1: 3mm Red (2)
- LD2: 3mm Red (2)

11. Transistors.

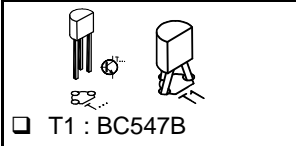

12. Potentiometer

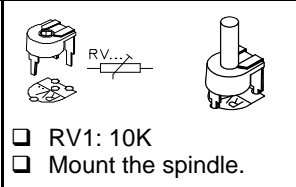

13. VDR

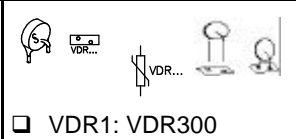

14. Terminal block connectors.

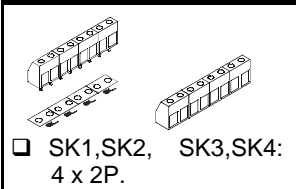

15. Fuseholder & Fuse. *Watch the position !*

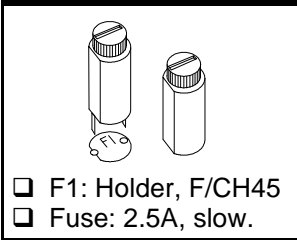

16. Relay



17. IC, *Check the position of the notch !*

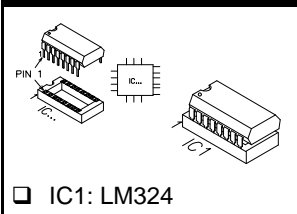

1. **Connect the mains voltage** (110-230V AC) through connections L1 & L2 of connector SK1.
 2. **Connect the main device** (the device you (de)activate yourself) with the 'MASTER' connector SK2.
 3. Between 'COM' and 'NO' you will find the NO contact of the relay, which is closed in case of current consumption by the 'MASTER' device. The NO contact enables you to switch a max. Load of 5A.
 4. You can also install a jumper (a piece of copper wire of 1.5mm²) between the 2 connections of SK3 (L1 & COM). You can then simply connect the device to be activated automatically (SLAVE) with the remaining connections 'NO' and 'L2' of SK4. This makes it easy to establish connections, but remember that the **joint electric current requirement** of MASTER and SLAVE device is limited to **max. 2A** (see p. 9).
- Turn potentiometer RV1 to the far right.
 - LD1 should light when MASTER and SLAVE are placed under tension. The 'MASTER' device should also work now when activated.
 - Activate the 'MASTER' device. There is sufficient power consumption in the MASTER line if the 'SLAVE' is already activated. In this case, there is no need to make further adjustments. If the 'SLAVE' is not activated: turn the potentiometer slowly to the left until the 'SLAVE' device is activated (LD2 lights). Use RV1 to determine the minimum electric current requirement for the MASTER that will still activate the 'SLAVE' as well.



REMARK: A small delay may occur when the device is activated or deactivated. This delay limits the current spike that occurs in the mains and avoids instable behaviour of the 'SLAVE' in case of current variations in the 'MASTER' device.

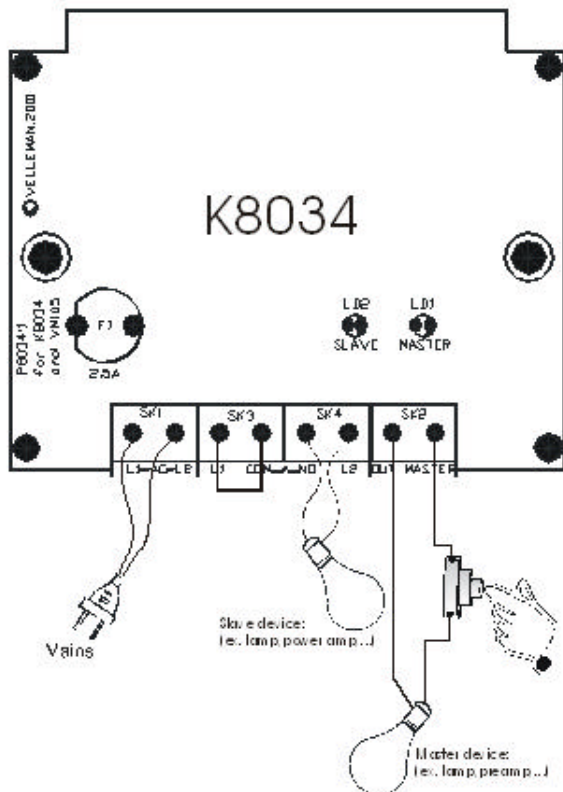

18. PCB layout.

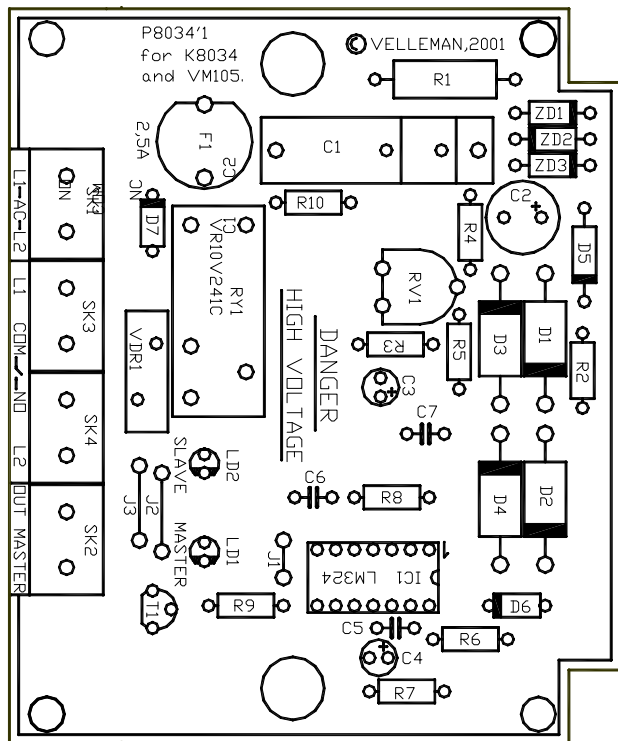

19. Schematic diagram.

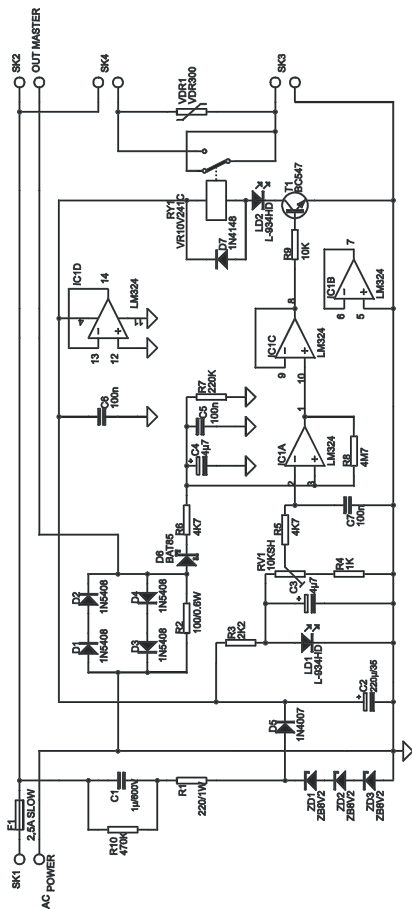

VELLEMAN Components NV
Legen Heirweg 33
9890 Gavere
Belgium Europe
www.velleman.be
www.velleman-kit.com

Modifications and typographical errors reserved
© Velleman Components nv.
H8034IP - 2001 - ED1